

PBP3-BG Pickleball Post

Posts: The posts are made of 3-1/2" galvanized steel pipe.

Net Tightener: Net tightener allows for easy and accurate tenting of top cable or rope of the net to set the proper center height of the net. The handle is easily removed after tenting is set.

Finish: Posts are powder coated in green or black.

Warranty: 10 Year limited.

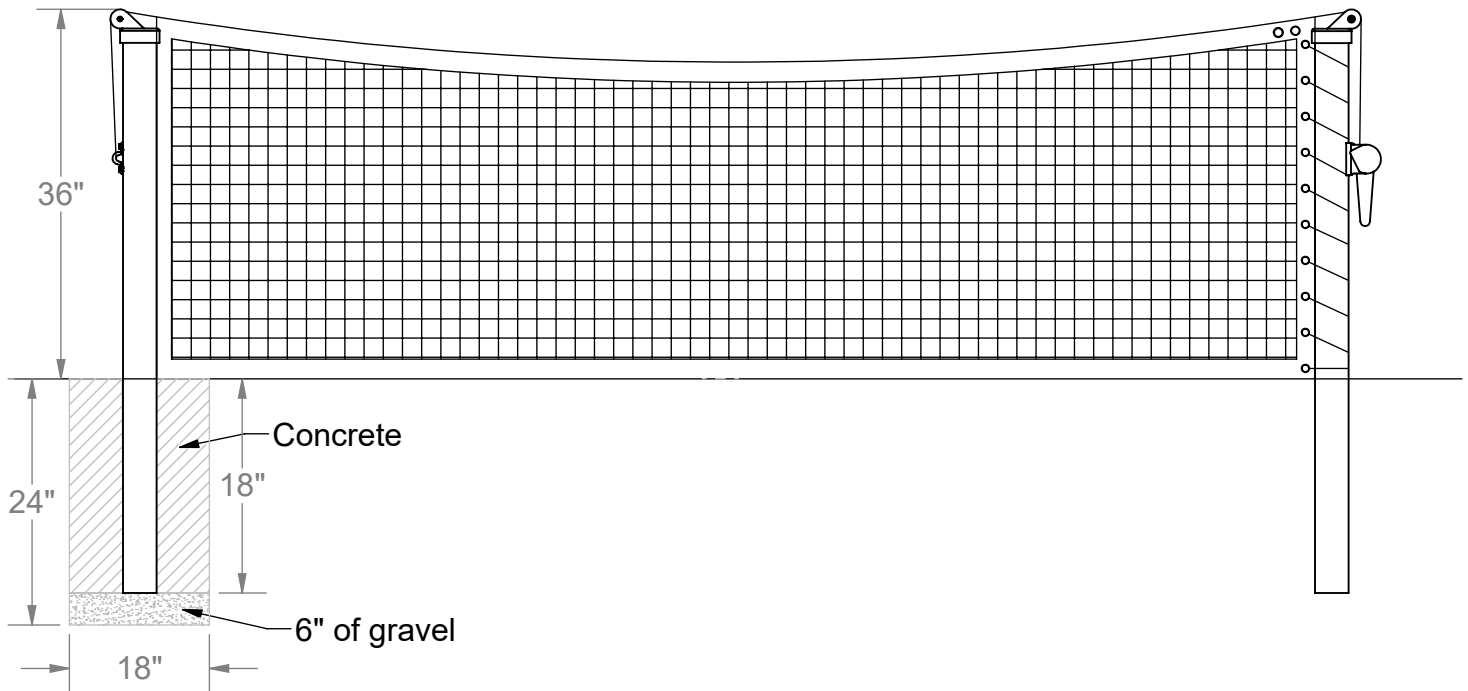

Installation Instructions:

- 1) Dig footings for poles according to diagram on above 22 feet apart inside of pipe to inside.
- 2) Ensure proper height of poles. Plumb and square post, pour concrete and let concrete cure for 3 days before attaching net and putting into service.
- 3) Use the Stainless Steel net guide to bolt the top cable end loop to one pole. Run line over the top pulleys and use the other loop to connect it to the net tightener. Tension the net till the center of the net is 34 inches above the court.
- 4) Use the supplied rope to secure the net to the post by wrapping it through the eyelets and around the post.



Date: 1/19/2021

Rev: A

Drawn: JBN

Sheet: 1 of 2

SPECIFICATION / INSTALLATION INSTRUCTIONS

Pickleball Post Model

MODEL NO.

PBP3-BG

Pickleball court dimensions

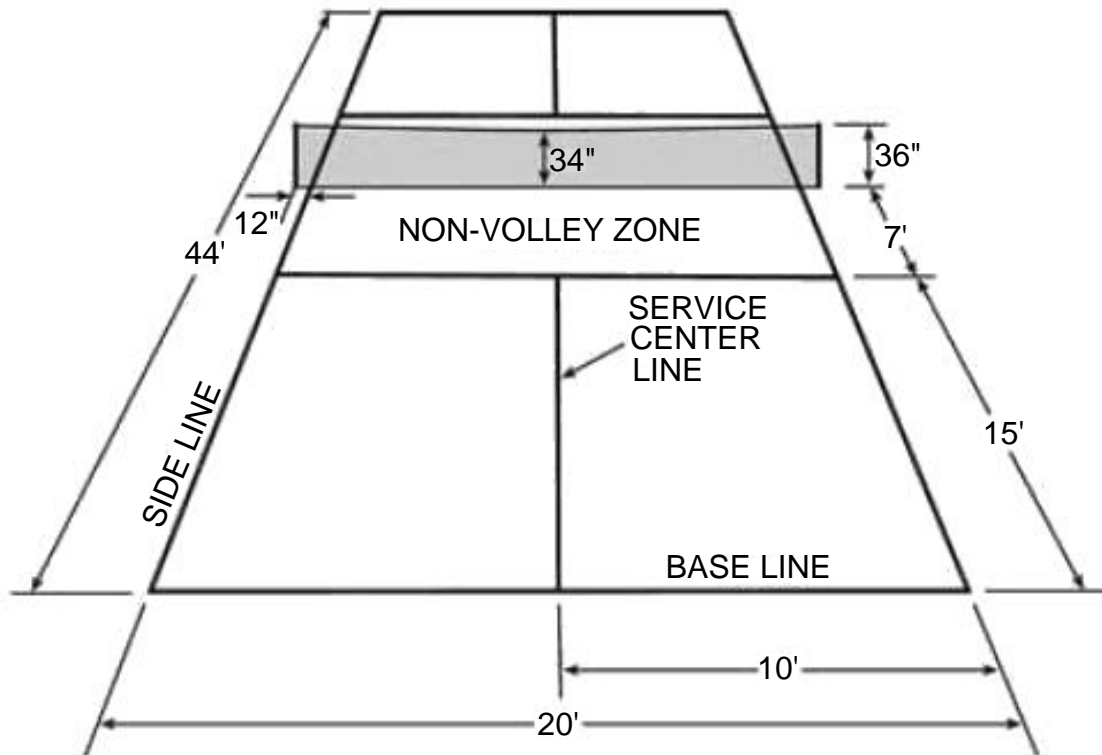

ITEM NO.	PART NUMBER	DESCRIPTION	QTY.
1	RMPIP312	Pickleball Post	2
2	CINETTOP35BLK/GRN	Top Pulley Cap in Black or Green	2
3	8321NT	Net Tightener Assembly	1

KHWTP - Hardware Kit - Contains the following hardware pcs.

1	HWHB5161	5/16" X 1" Hex Bolt	4
2	HWHB516112	5/16" X 1-1/2" Hex Bolt	2
3	HWSPLW516	5/16" Split Washer	4
4	HWFLWA516	5/16" Flat Washer	6
5	HWLN516	5/16 Nylok nut Zinc	2
6	HWNGSS	Stainless Steel Net Guide	1
7	HWSC3838	3/8 X 3/8" Set Screw Zinc	6
8	LA-VCIPULLEY1	Aluminum pulley 7/16" x 1"	2



Date: 1/19/2021
Rev: A

Drawn: JBN
Sheet: 2 of 2

SPECIFICATION / INSTALLATION INSTRUCTIONS

**Pickleball Post Model
PBP3-BG**
MODEL NO.