

# SINGLE BASKETBALL POST

**MODEL #LA-BBCP-4** 4-1/2" O.D. WITH 4' OFFSET W/O BRACING (178 LBS)  
**MODEL #LA-BBCP-46** 4-1/2" O.D. WITH 6' OFFSET W/O BRACING (178 LBS)

*Verify vertical position of mounting plate using level.*

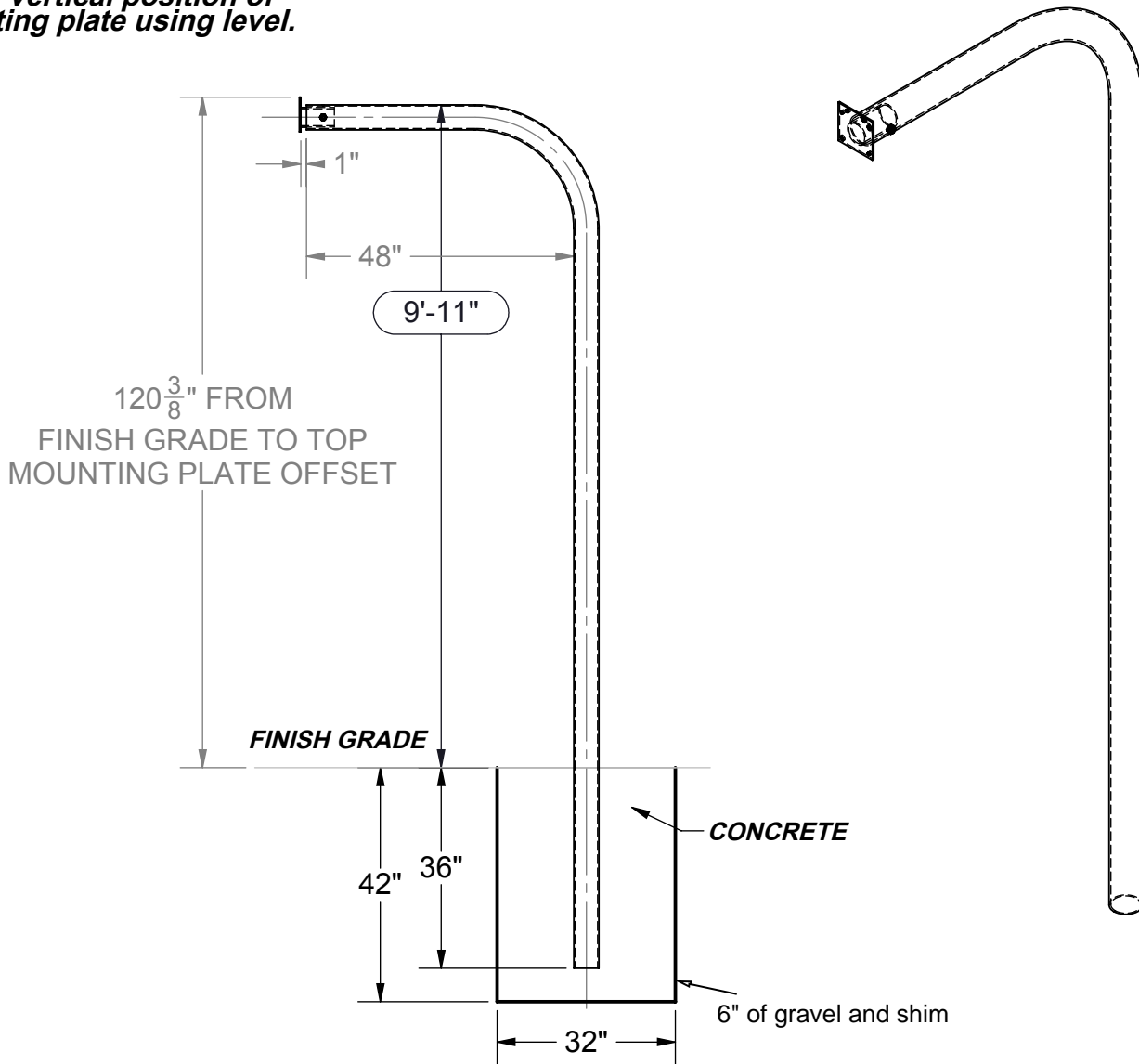

## **SPECIFICATIONS:**

**Material:** Support post is a single length of 4-1/2" O.D. galvanized steel formed to provide a graceful 4 ft or 6 ft offset. Backboard mount is a 6-1/4" x 6-1/2" schedule 40 steel plate welded to the sleeve adapter then mounted to support post with set screw & drive pin.

All welds are ground smooth and either treated with cold-galvanizing compound or prepared for powder coating, depending on finish selected. All hardware is zinc-coated for long rust-free service.

 <p><b>Steelcraft</b> ELEMENTS FOR LIFE OUTSIDE<sup>®</sup></p> <p>www.LASTEELCRAFT.com 1-800-371-2438</p>	Date: 2/23/16	<b>SPECIFICATION / INSTALLATION INSTRUCTIONS</b>
	Rev: DH5/11/20	
	Drawn: MT	MODEL NO.
	Sheet: 1 of 2	<b>LA-BBCP-4, LA-BBCP-46</b>

# PERMANENT FOOTING DETAIL

**NOTE:** Footing sizes are based on average soil conditions. Loose and/or sandy soil is not average and footing sizes must be increased accordingly to meet soil conditions and local building codes and specifications. Post depth is approximate, and should be adjusted to ensure that the top of the Gooseneck offset post is **9'-11"** above finish grade.

## **INSTALLATION INSTRUCTIONS:**

1. Dig a hole in desired location per footing chart dimensions. Set the bottom of the post in center of the hole and shim from below or fill such that the top of the Gooseneck Post on the offset is **(9' 11")** above finish grade. Plumb post true vertical and brace. NOTE: Top of rim will be at 10' when installed.

**NOTE:** Verify that the backboard mounting plate is perpendicular to the surface by using a level (vertical) before pouring concrete.

2. Pour concrete and allow the concrete to set for 3 days before removal of bracing and completion of installation. Cover footings with court materials.
3. \*Refer to backboard installation instructions to complete backboard & GNP Adapter installation.\*
4. Once everything is tightened drill 1/4" Drive Pin holes in the GNP Adapter through the Gooseneck holes on top & bottom of offset end with a 7/32" Drill Bit (Not included).

Packing Slip	Qty
<b>LA-BBCP-4</b>	
4-1/2" O.D. 4' Offset Gooseneck Post	1
4-1/2" GNP Adapter	1
OR	
<b>LA-BBCP-46</b>	
4-1/2" O.D. 6' Offset Gooseneck Post	
4-1/2" GNP Adapter	
<b>Hardware Kit</b>	
5/8"-11 x 1" Socket Hd. Set Screw	1
1/4" Drive Pin	2

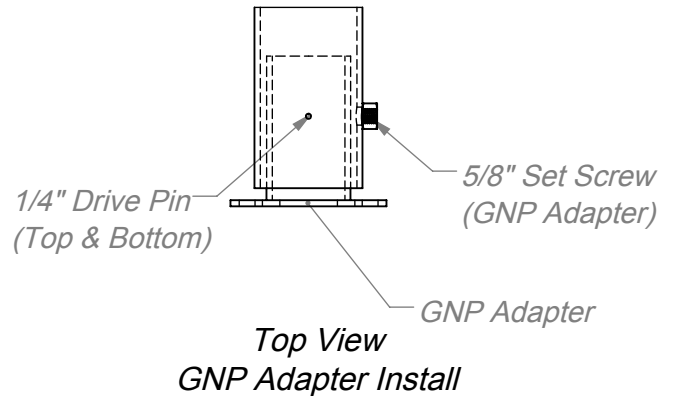

Date: 2/23/16  
Rev: DH5/11/20  
Drawn: MT  
Sheet: 2 of 2

## **SPECIFICATION / INSTALLATION INSTRUCTIONS**

### *SINGLE POST GOOSENECK*

MODEL NO.

**LA-BBCP-4, LA-BBCP-46**