

# 62' LAYBACK ARCH BACKSTOP

□ MODEL #LA-AB-62L - LAYBACK ARCH BACKSTOP 20'H x 20'D x 62'W (4,000 LBS)

OVERHEAD and BASE Arches: 2-7/8" O.D. galvanized steel.

Vertical Ribs: 2-3/8" O.D. galvanized steel. Ribs shall be formed to a smooth continuous radius throughout the entire length of each rib.

Flattened Sleeves: 1-7/8" O.D. galvanized steel, factory flattened and punched.

Horizontal Stiffeners: 1-3/8" O.D. galvanized steel, secured between vertical ribs with 2-way split clamps (galvanized), zinc plated 5/16" x 1-1/4" carriage bolts split washers and hex nuts. Where stiffeners connect to outside ribs, 3/4" wide galvanized steel brace bands shall be used along with 5/16" x 1" carriage bolts split washers and hex nuts. Any exposed threads to be destroyed by Installer.

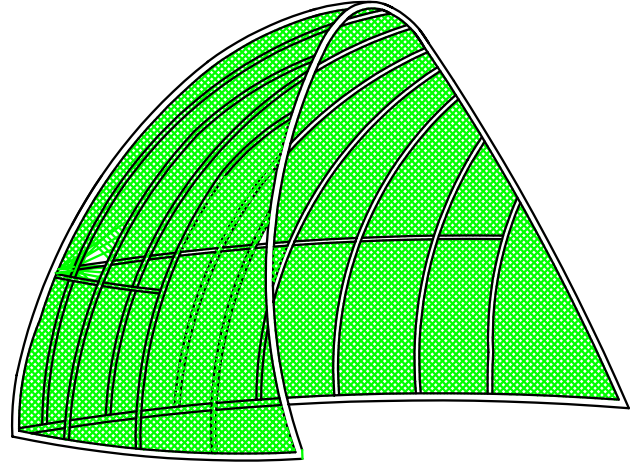

25° LAYBACK



Date: 5-22-08  
 Rev: A060812  
 Drawn: AMC  
 Sheet: 1 of 10

**SPECIFICATION/INSTALLATION INSTRUCTIONS**  
 62' LAYBACK ARCH BACKSTOP  
 MODEL NO.  
**LA-AB-62L**

Main Footing Anchors: 2-7/8" O.D. galvanized steel, welded sleeves that fit into BASE and OVERHEAD arch ends (2-3/8" O.D. galvanized steel). Footing anchors shall extend 3 feet into footings and shall be welded at the bottom with one piece of 6" long angle (2" x 2" x 3/16") steel, to form an anchor in the concrete footing.

Anchor Bolts: 5/8" x 12" foundation bolts, extending throughout BASE arch and shall be evenly spaced between vertical ribs. Any exposed threads to be destroyed by Installer.

Tension Bars: 3/4" galvanized and shall be secured with galvanized tension bands spaced 18 inches on center and bolted with 5/16" x 1" zinc-plated carriage bolts lock washers and hex nuts. Threads to be destroyed by Installer 10 feet up on overhead arch. Tension bars shall be installed along inside overhead arch.

Chain Link Fabric: Fabric shall be 9-gauge on all models except top (second) course shall be 11-gauge. It shall be installed horizontally in single lengths to outside of backstop using 12-gauge galvanized wire ties every 12 inches along vertical ribs. Edges shall be over-lapped a minimum of 1" to 2" and tied together with 9-gauge, #3 galvanized hog rings every 6 inches along seams. Fabric shall be pulled tight around curvature of backstop and shall be cut and trimmed in a neat and professional manner. Where wire is cut, exposed barbs shall be bent double to leave a knuckled edge, and should be cut along the rib.

Heavy Duty Rib Collars: Custom made 2-7/8"

Heavy Duty Rib Adapter Collars.

Concrete Footing: Footings for OVERHEAD arch shall be 4' deep x 3' in wide. This is to allow the anchors to retain the proper angle going into the footing. this is an important step in insuring that your backstop will be easy to erect, and retain the proper rolled radii. Footings for BASE arch anchor bolts shall be 18" deep x 18" in. Concrete not included. See footing details on page 9.

Finish: All pipe and hardware is galvanized steel. All fasteners are zinc-plated except anchor bolts.

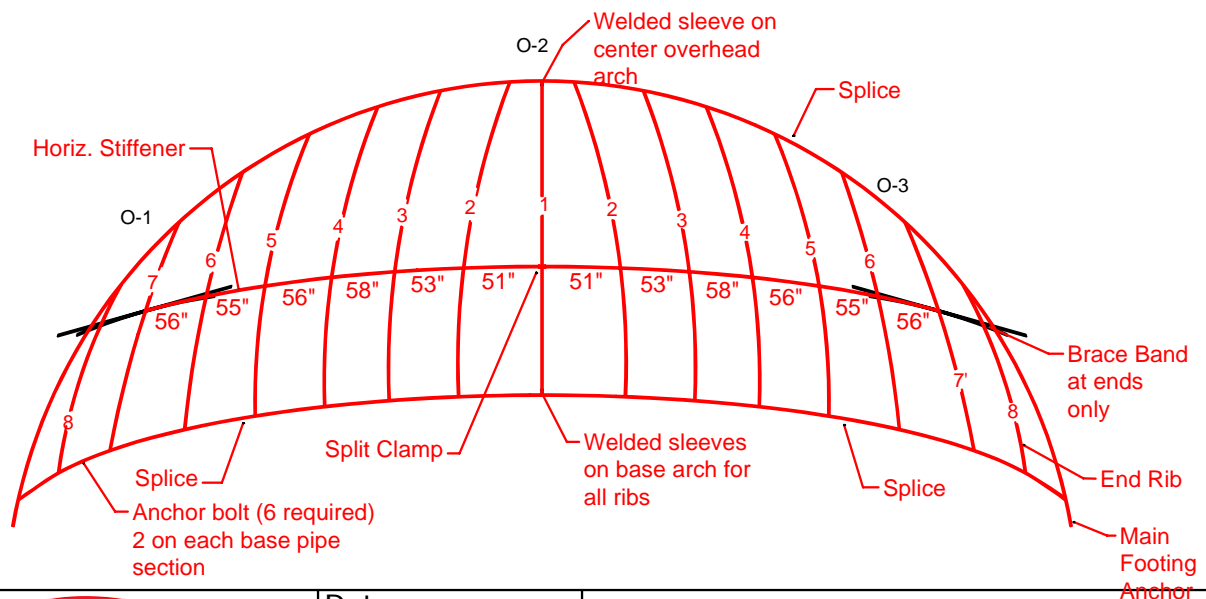

 <p>www.LASTEELCRAFT.com 1-800-371-2438</p>	Date: 5-22-08	<b>SPECIFICATION/INSTALLATION INSTRUCTIONS</b> 62' LAYBACK ARCH BACKSTOP
	Rev: A060812	
	Drawn: AMC	MODEL NO.
	Sheet: 2 of 10	<b>LA-AB-62L</b>

**GENERAL NOTES:**

- I. Check materials received with the parts list (Page 10) to make sure that all components are included and to assure that the unit is complete.
- II. The site must be level not more than +/- 1" variation from mean elevation over the entire length and depth of the base arch.
- III. A construction-type forklift with a 20-foot boom capacity and scaffold will be necessary to assemble frames and attach wire mesh.
- IV. The base and overhead arches are 2-7/8" O.D. and consist of three curved sections. The center sections of both the overhead and base arches have internal sleeves (2-3/8" O.D.) welded on each end and another external stub (1-7/8" O.D.) welded in the middle for center rib attachment. They are marked as follows:

Left end - BASE Arch            B-1    Center - BASE Arch            B-2    Right end - BASE Arch            B-3  
 Left end - OVERHEAD Arch    O-1    Center - OVERHEAD Arch    O-2    Right end - OVERHEAD Arch    O-3

**Extremely Important:**

Before assembling the overhead arch:

- 1. On center arch (O2), slide four (4) rib adapter collars on each side of welded sleeve.
- 2. On left (O1) arch and right (O3) arch, slide three (3) rib adapter collars.
- 3. Secure sections with 5/8" x 4" Hex Bolts, Washer, and Nylocks.

**DO NOT POUR CONCRETE UNTIL ENTIRE FRAME IS ASSEMBLED**

LA has noted the size of the main anchor footings as a guide line, and asks that you check with your local permit authorizing personnel, or your architect before proceeding, as your area of the country might require larger footings.

Footing must be wide enough to allow anchor to be placed at the approx. angle shown (See Detail B page 9). The angle must be adjusted to form arch and maintain width of backstop. Anchor **MUST NOT** touch sides of footing.

LA has also noted this particular size, so the main anchors may swivel on the base arch to properly align with the overhead arch, the anchor must freely hang in footing and not touch sides of footing. When installing, place the anchors in the base arch, and leave them FINGER TIGHT ONLY, at this time. Place the overhead arch onto the main anchors and finger tighten at this time. This allows the overhead arch to settle in the proper angle and sphere to insure trouble free alignment with the ribs.

ONLY after assembling the entire arch, go back and tighten all set screws with proper sized allen wrenches at this time.

**FRAME ASSEMBLY**

1. Assemble the Base Arch:

- 1.1 Locate the three sections of the base arch. (B-1, B-2 & B-3) (Standing inside the base arch B-1 and B-3 are on your left and right respectively).
- 1.2 Begin by connecting the three sections (B-1, B-2 & B-3) of the base arch together using set screws provided. Make sure the end sleeves on B-2 are fully seated. Set in proper field location. Measure 62' outside to outside and adjust as necessary to conform to the 62' dimension. Mark the location of the main footings at each end of the base arch. Mark the 6 anchor bolt locations at each pre-drilled hole on B-1, B-2 and B-3.
- 1.3 Move base arch aside and dig footings. Main anchor footing dimensions are 36" wide x 48" deep. Note: MAIN ANCHOR FOOTINGS SHOULD BE DUG TO ACCOMODATE THE ANGLE OF THE ANCHORS. Center the anchors in footing hole. (See Detail B page 9)
- 1.4 Relocate base arch to match footing locations. Measure outside to outside on base arch ends again and hold 62' dimension. Stake rear of base arch to prevent sliding when installing overhead arch. Note: Footing sizes are based on average soil conditions. Loose and/or sandy soil is not average and footing sizes must be increased accordingly to meet local soil conditions.

	Date: 5-22-08	<b>SPECIFICATION/INSTALLATION INSTRUCTIONS</b>  62' LAYBACK ARCH BACKSTOP
	Rev: A060812	
	Drawn: AMC	MODEL NO.
	Sheet: 3 of 10	<b>LA-AB-62L</b>

**Before assembling the overhead arch: (Note: A slight variation in tolerances is acceptable, however, you should strive to maintain recommended dimensions as close as possible.)**

1. On center arch (O2), slide four (4) rib collars on each side of welded sleeve.
2. On left (O1) arch and right (O3) arch, slide three (3) rib collars.
3. Secure sections with 5/8" x 4" Hex Bolts and Nylocks. Tighten before lifting overhead arch in the air.

**2. Assemble the Overhead Arch:**

- 2.1 Locate three sections of overhead arch (O-1, O-2 and O-3) and lay them on the ground in front of and directly opposite the base arch. (Standing inside the overhead arch) O-1 and O-3 will be on your left and right respectively). Make sure end sleeves on O-2 are fully seated. Use 5/8" x 4" Hex Bolts, washers & Nylocks to join arch sections together.
- 2.2 Raise assembled overhead arch into position using a forklift. Insert main footing anchors ) into both ends of base arch. Lower the overhead arch onto main footing anchors until fully seated. Leave forklift in position to support the overhead arch until vertical ribs are installed.
- 2.3 At connecting locations on the main footing anchors use set screws to hold in place until entire frame is assembled.

**CRITICAL NOTE: AFTER OVERHEAD ARCH, BASE ARCH, AND RIB#1 IS UP, STOP TO VERIFY OVERALL MEASUREMENTS (WIDTH, HEIGHT, AND DEPTH INCLUDING VISUAL INSPECTION OF ALIGNMENT) BEFORE PROCEEDING. USE A RACHET STRAP TIED AT EACH END OF THE BASE ARCH TO KEEP WIDTH DIMENSION IN PLACE UNTIL FRAME IS COMPLETELY ASSEMBLED.**

**3. Install Vertical Ribs:**

3.1.1 All vertical ribs are marked with numbers and should be installed in this order. Rib #1 is the center fixed rib. Insert bottom of center rib onto welded stub on the base arch. Hold back overhead arch and insert the top of rib #1 onto stub of overhead arch. Make sure rib and sleeve are seated on overhead & base arch. Tighten set screws to hold in place.

**Note: After Overhead Arch, Base Arch, and Rib #1 is up, STOP! and verify measurements (Width, Height, and Depth) and also check side view to observe overall shape before proceeding.**

3.1.2 Horizontal stiffeners (see sheet 7) are used between the ribs. There are different lengths of horizontal stiffeners. See Clamp Spacing Detail F on page 10 for correct location of each stiffener. Assemble one split half clamp on rib #1 using 5/16" x 1-1/4" carriage bolts, split washers and hexnuts and attach stiffener (51") to each side of clamp. Slide stiffeners and clamps up the rib to approximately 6' above finish grade. Only tighten bolts enough to hold in place.

3.1.3 To install remaining ribs, locate the rib adapter collars that were slid onto the overhead arches done before step 1. Locate the flattened end sleeves. (See Detail A, D & E page 8) Insert flattened sleeve into top of rib #2 and assemble to rib collar.

3.1.4 In an alternating sequence, install the remaining ribs, 2, 3, 4, 5, 6, 7 & 8, installing one rib to each side of previous rib.

(See Detail page 8) Do not tighten bolts fully tight until all stiffeners and clamps are in place.

3.1.5 Attach ribs #7 to top and bottom arches and use 56" stiffener (see detail page 8) to hold them in place. Use 2-3/8" brace bands on end rib #7. Adjust ribs and stiffeners as needed for horizontal and vertical continuous curved appearance.

3.1.6 Make sure all sleeved joints are seated and proceed to tighten all bolts and set screws.

3.1.7 Install anchor bolts and nuts in the holes on base arch. Thread nuts on anchor bolts until two threads are protruding out of nut. Make sure the anchors are centered in footing holes. (See Detail D page 9)

**NOTE: BEFORE CONTINUING, PERFORM A VISUAL INSPECTION. CONFIRM THAT THE RIBS FORM A SMOOTH CURVATURE ALONG THE BACK SIDE OF THE ARCH.**

3.1.8 Check for overall frame alignment and adjust frame before pouring concrete. Pour concrete in the large main footing holes to within 2" of finished grade. (See Detail H page 7) Pour anchor bolt footings up to finished grade. Allow concrete to set for 3 days before completion of install. After footings have set cover main footings with dirt or turf. Note: Footing sizes are based on average soil conditions. Loose and/or sandy soil is not average and footing sizes must be increased accordingly to meet local soil conditions.

	Date: 5-22-08	<b>SPECIFICATION/INSTALLATION INSTRUCTIONS</b>  62' LAYBACK ARCH BACKSTOP
	Rev: A060812	
	Drawn: AMC	MODEL NO.
	Sheet: 4 of 10	<b>LA-AB-62L</b>



5) Installation of WIRE MESH

Mesh is installed in 2 courses:

- 5.1) 1st or Bottom Course: 2" - 9ga x 12' width (Combine lengths of mesh to fit bottom course).
- 5.1.2) Stand the wire up on edge and position on the outside of the frame so the bottom edge is flush with the bottom of the BASE arch, and so it is centered.
- 5.1.3) Secure the mesh to the center rib only with tie-wire on 12" centers.
- 5.1.4) Pull the mesh tight to each end. Trim the excess on the bias about 2" short of the OVERHEAD arch at both ends to allow room for tension bars and bands.
- 5.1.5) Install one 12' tension bar in the mesh at each end (parallel to OVERHEAD arch) so the tops of the bars are flush with the top of the mesh. Where the bars do not fit through the mesh properly, the cut ends of the wire must be twisted around the bars to prevent unraveling of the mesh. Make sure there are no exposed sharp wires. (See Detail page 7)
- 5.1.6) Pull mesh as tight as possible, as it will save having extra work later.
- 5.1.7) Install tension bands on 18" centers on the OVERHEAD arch up to the top of the mesh. Secure bands with 5/16" x 1" carriage bolts split washer and nuts with carriage heads facing outside.
- 5.1.8) Tighten hardware securely.
- 5.1.9) If the top few feet of the mesh are still loose or sag between ribs, then proceed with this step:
  - a) Starting at the center rib at the top of the mesh cut the mesh along the rib downward to about 12" above where the mesh is tight. NOTE: Never cut the mesh more than 12" below the stiffeners (1-3/8" O.D. pipe between the ribs).
  - b) Pull the mesh tight starting at the bottom of the cut working upward using hog rings to secure approximately every other diamond.
  - c) Cut away the excess (the usual amount of excess at the top is 4" to 6") allowing enough wire left to twist the ut ends together.
  - d) Use more hog rings and/or tie wire as necessary to completely secure the seam (see Mesh Detail I page 7).
  - e) If the top of the mesh is still loose or sags, repeat step 5.1.9 for each rib until it is tight. NOTE: This does not necessarily mean this needs to be done at every rib, only until tight. Work from center rib outward alternating right and left. At some of the outer ribs cutting may not be necessary but it may be necessary to gather one or two strands of mesh and secure with hog rings.
- 5.1.10) Secure the mesh to all of the ribs with tie wire on 18" centers.
- 5.1.11) Install the bottom 10' tension bars in the second diamond up from the bottom of the mesh. Feed the bars through the mesh starting at one end working to the opposite end.
- 5.1.12) Overlap the ends of the tension bars a few inches at the ends. The last tension bar must be cut to size so it its flush with the inside edge of the OVERHEAD arch. Note: The bars must be installed after the mesh is tight (if not, the mesh will not conform to the shape of the backstop).
- 5.1.13) To install tension bands, it may be necessary to loosen nuts on anchor bolts and raise the BASE arch slightly so they will fit underneath. Install bands on 18" centers all along the BASE arch. Secure with 5/16" x 1" carriage bolts, split washer & nuts (with heads facing outside of the tension bars) along the BASE arch. Use hog rings to secure overlap of tension bars.
- 5.1.14) Tighten anchor bolt nuts securely so the BASE arch is in contact with the anchor bolt footings. Peen any excess threads to prevent removal.

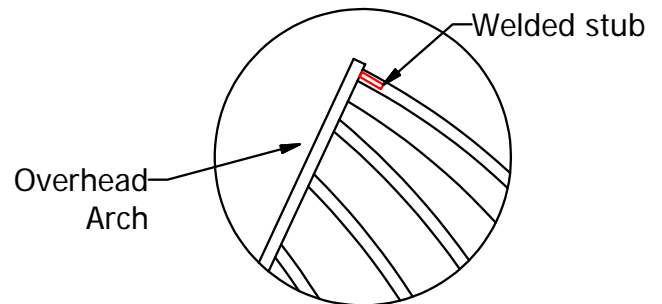

	Date: 5-22-08	<b>SPECIFICATION/INSTALLATION INSTRUCTIONS</b> 62' LAYBACK ARCH BACKSTOP
	Rev: A060812	
	Drawn: AMC	MODEL NO.
	Sheet: 5 of 10	<b>LA-AB-62L</b>

- 5.3) 2nd or Top Course: 2" - 11ga x 12' width (Cut mesh length to fit top course)
- 5.3.1) Center the mesh on the frame so the top edge of the third course is flush with and parallel to OVERHEAD arch. The excess mesh at the bottom of the third course will overlap the top of the second course. (DO NOT trim at this time.)
- 5.3.2) Install a 12' tension bar (along overhead arch) in the mesh at the center where the center rib (rib No. 1) sleeves to the OVERHEAD arch. Working from the center out, install tension bands on 18" centers while stretching mesh tight in an outward direction.
- 5.3.3) Stretch the mesh downward and secure to the center rib with tie-wire on 12" centers.
- 5.3.4) Add remaining tension bars and bands as before alternating from left to right of center, while pulling the mesh tight in an outward direction along the OVERHEAD arch. Allow 2 inches of overlap at the ends of the tension bars.
- 5.3.5) Cut the tension bars to size where they meet the second course at the OVERHEAD arch, again allowing a few inches of overlap. Where tension bars overlap, use hog rings to secure.
- 5.3.6) Pull the wire mesh tight in a downward direction and secure to every rib with tie-wire on 18" centers.
- 5.3.7) The bottom few feet of the mesh (on the third course) may be loose. Gather one or two strands at the center rib and use hog rings to secure at every diamond. If still loose, repeat this alternating from right to left of center. This does not necessarily mean this has to be done at every rib; only do so until tight.
- 5.3.8) Trim the bottom edge of the third course even with the top of the second course, allowing a one-diamond overlap.
- 5.3.9) Secure the two courses of mesh together with hog rings every other diamond. Twist cut wire ends around the second course making sure no sharp wires are exposed.
- 5.3.10) Inspect complete backstop for loose hardware, fittings, and sharp wires. Repair as necessary.
- 5.3.11) Replace turf over main anchor footings.

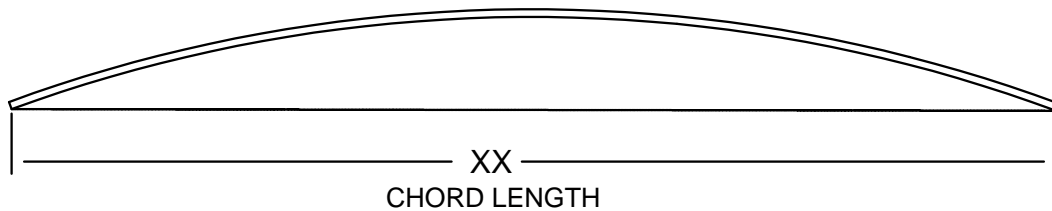

Note: Chord length measured in a straight line from one end of pipe to other end.

 <b>Steelcraft</b> <small>ELEMENTS FOR LIFE OUTSIDE™</small> <small>www.LASTEELCRAFT.com</small> <small>1-800-371-2438</small>	Date: 5-22-08	<b>SPECIFICATION/INSTALLATION INSTRUCTIONS</b>
	Rev: A060812	
	Drawn: AMC	MODEL NO.
	Sheet: 6 of 10	<b>LA-AB-62L</b>

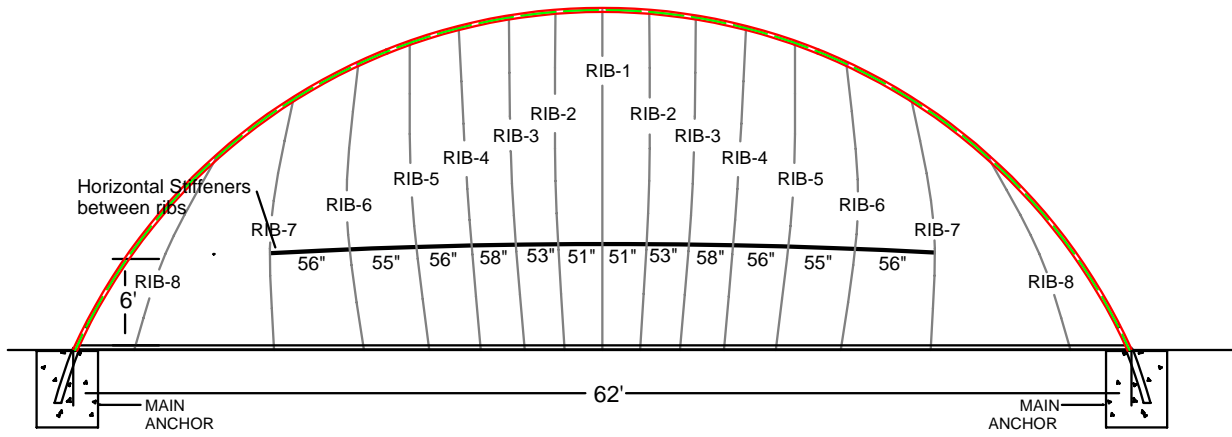

**DETAIL-H**

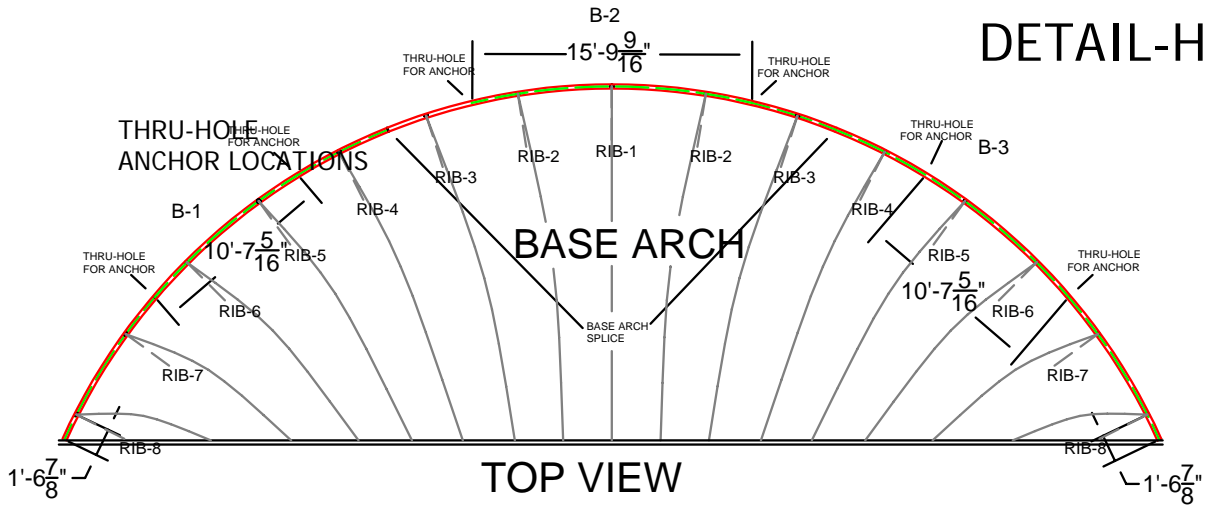

**DETAIL-I**

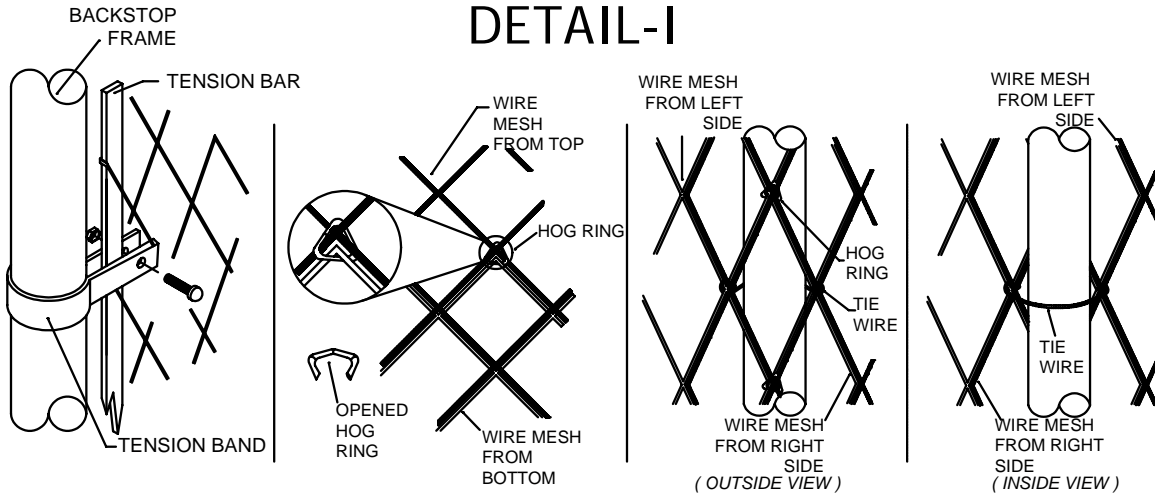

Date:	5-22-08
Rev:	A060812
Drawn:	AMC
Sheet:	7 of 10

<b>SPECIFICATION/INSTALLATION INSTRUCTIONS</b>	
62' LAYBACK ARCH BACKSTOP	
MODEL NO.	<b>LA-AB-62L</b>

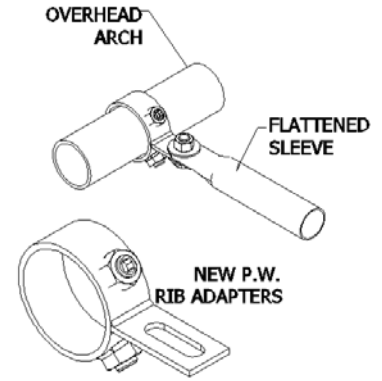
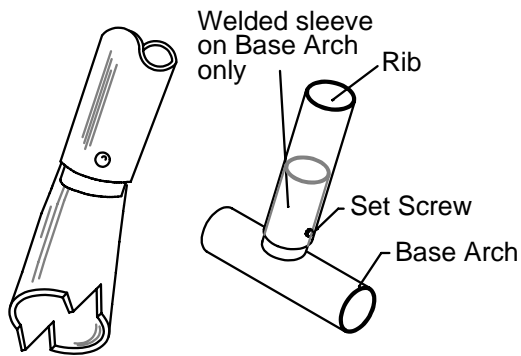
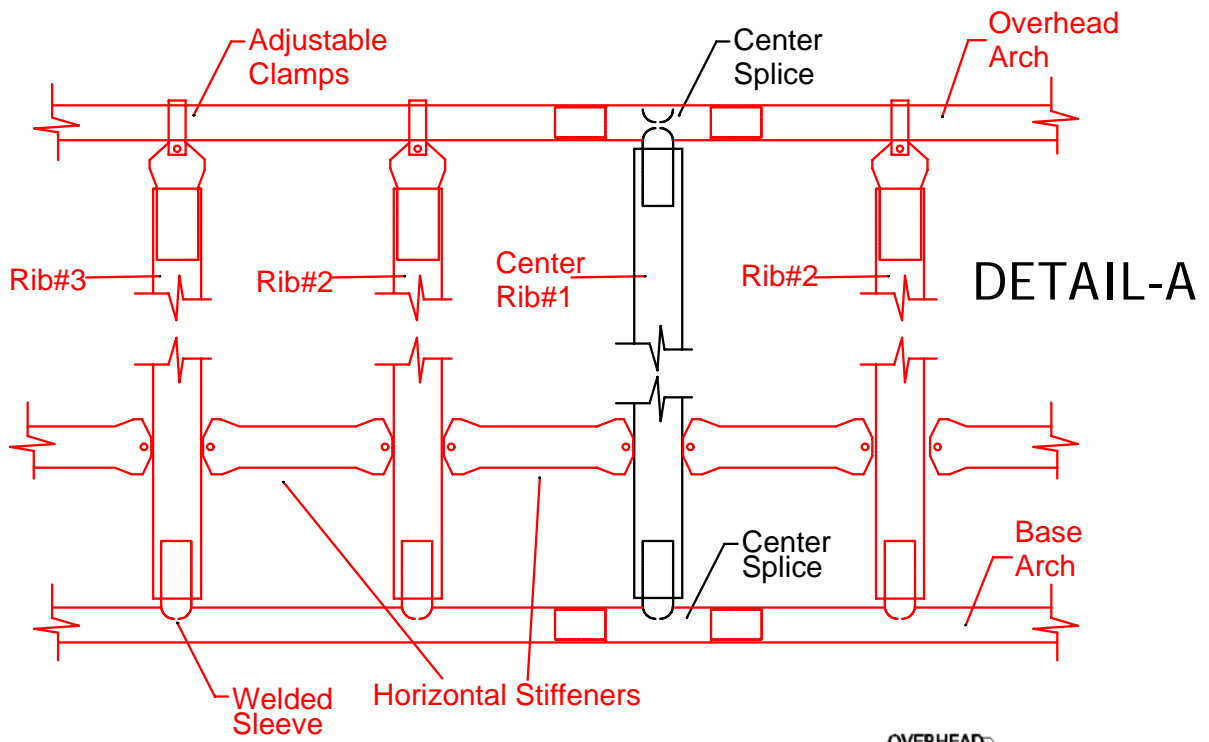

DETAIL-D

DETAIL-E

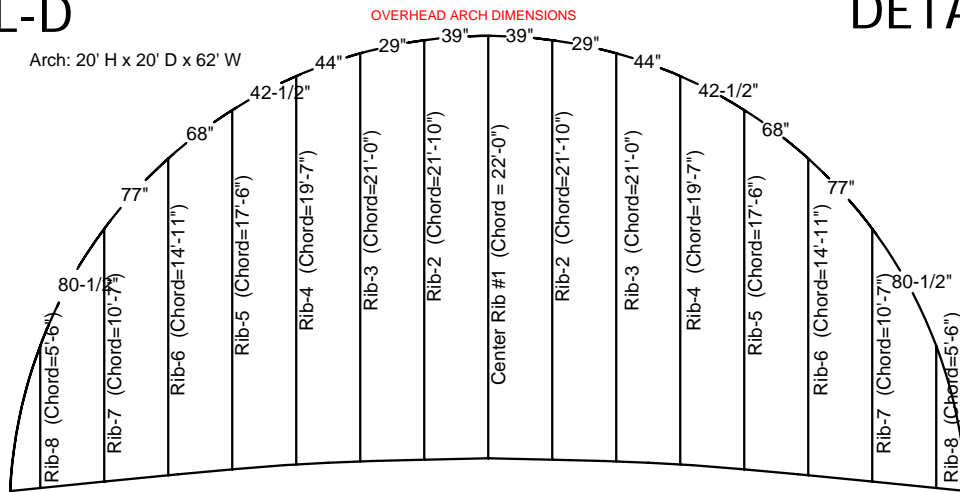

CLAMP SPACING DETAIL "G"

 <p>www.LASTEELCRAFT.com 1-800-371-2438</p>	Date: 5-22-08	<b>SPECIFICATION/INSTALLATION INSTRUCTIONS</b>
	Rev: A060812	
	Drawn: AMC	MODEL NO.
	Sheet: 8 of 10	<b>LA-AB-62L</b>



# FOOTING DETAILS

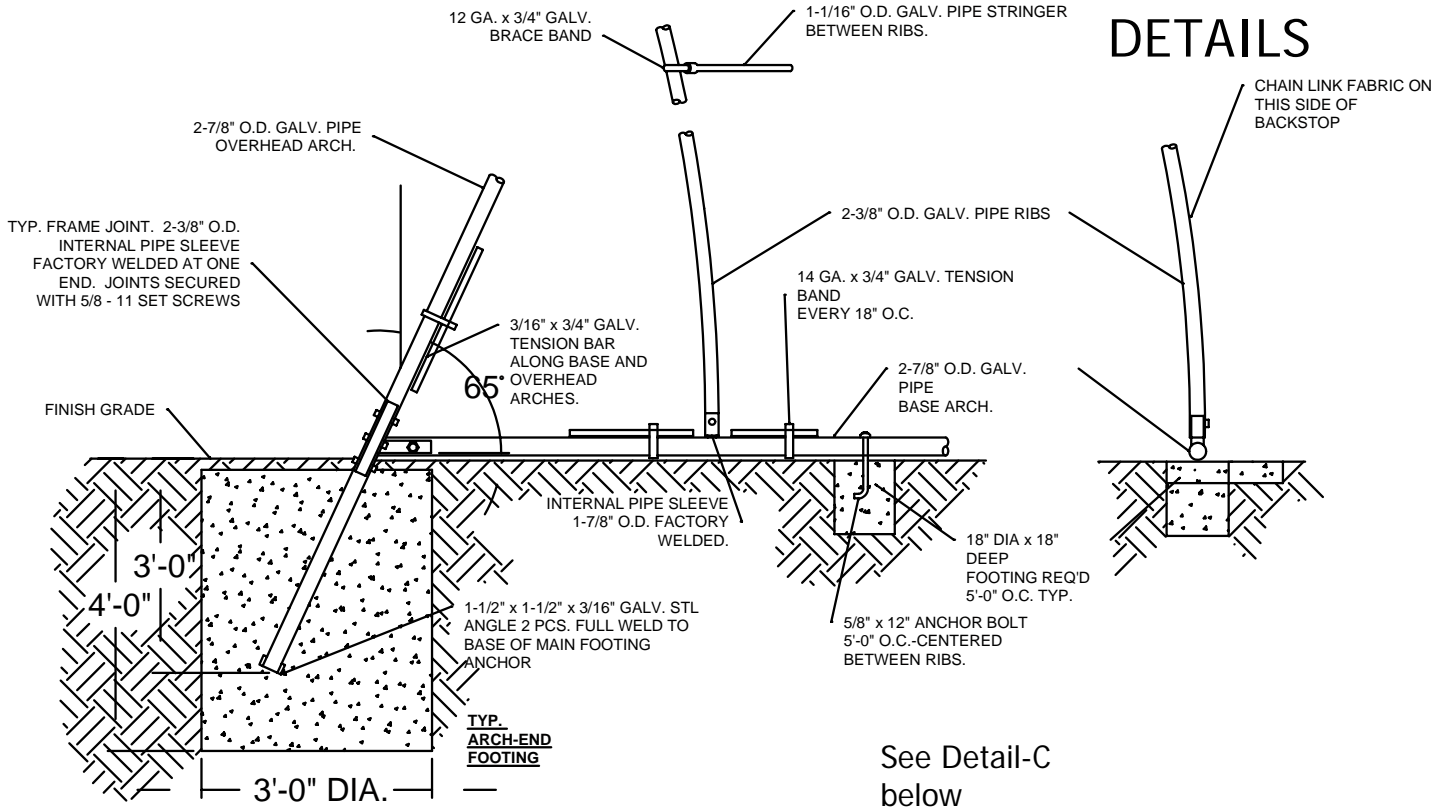

VIEW FROM PITCHING MOUND

## DETAIL-B

NOTE: Anchor Footings should be 62' center to center. This is to allow the anchors to retain the proper angle going into the footing. This is an important step in insuring that your backstop will be easy to erect, and retain the proper rolled radii.

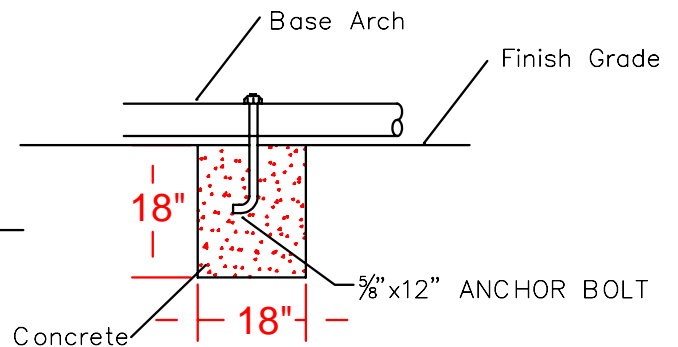
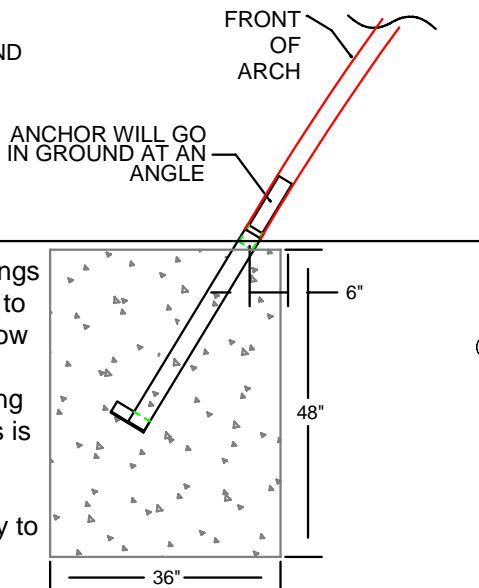

## DETAIL-C



Date:	5-22-08
Rev:	A060812
Drawn:	AMC
Sheet:	9 of 10

<b>SPECIFICATION/INSTALLATION INSTRUCTIONS</b>	
62' LAYBACK ARCH BACKSTOP	
MODEL NO.	<b>LA-AB-62L</b>

## DETAIL-F

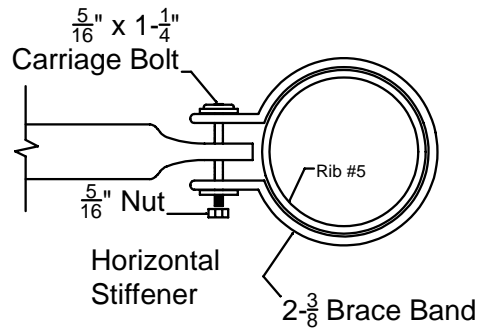
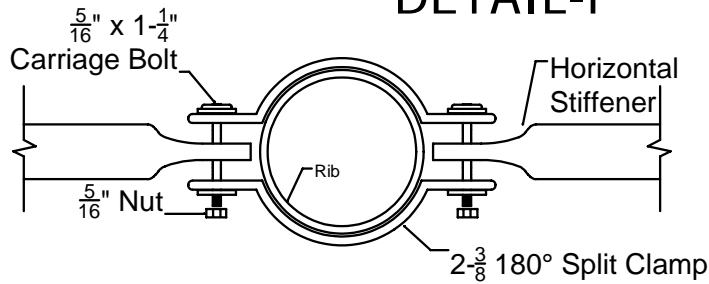

Description	Qty
Left End Base Arch(2-7/8" O.D.)(B-1)	1
Center Base Arch(2-7/8")(B-2)	1
Right Base Arch (2-7/8")(B-3)	1
Horizontal Stiffener - 51"	2
Horizontal Stiffener - 53"	2
Horizontal Stiffener - 55"	2
Horizontal Stiffener - 56"	4
Horizontal Stiffener - 58"	2
Rib Assembly - 1 (2-3/8" O.D.)	1
Rib Assembly - 2 (2-3/8" O.D.)	2
Rib Assembly - 3 (2-3/8" O.D.)	2
Rib Assembly - 4 (2-3/8" O.D.)	2
Rib Assembly - 5 (2-3/8" O.D.)	2
Rib Assembly - 6 (2-3/8" O.D.)	2
Rib Assembly - 7 (2-3/8" O.D.)	2
Rib Assembly - 8 (2-3/8" O.D.)	2
Left End Overhead Arch (O-1)	1
Center O/H Arch (O-2)	1
Right Overhead Arch (O-3)	1
Backstop Anchor	2
8' Tension Bar	2
10' Tension Bar	18
12' Tension Bar	2
2" X 11 Gauge X 12' Wire Mesh (ft)	50
2" X 9 Gauge X 12' Wire Mesh (ft)	150
Hardware Kit	1

Component Description	Qty
2-7/8" Tension Band	134
2-3/8" Brace Band	2
2-3/8" 180 Degree Split Clamp Band	26
5/16"-18 X 1" Carriage Bolt	136
5/16"-18 X 1-1/4" Carriage Bolt	26
5/16"-18 Hex Nut	162
5/16" Flat Washer	162
5/16" Split Washers	162
Hog Ring #3 Galvanized - (lbs)	5
5/8" x 4" Hex Bolts	4
5/8" Nylock	4
5/8"-11 X 12" Anchor Bolt	6
5/8"-11 Hex Nut	6
2-7/8" HD PW Rib Collars	14
3/8" x 5/8" set screws	28
3/8"-16 X 1 Grade 5 Hex Head Bolt	14
3/8" Flat Washer	28
3/8"-16 Lock Nut (Nylock)	14
5/8" x 7/8" Socket Head Set Screw	50
Flattened Sleeves	14
11 Gauge Tie Wire (lbs)	17



Date: 5-22-08  
 Rev: A060812  
 Drawn: AMC  
 Sheet: 10 of 10

### SPECIFICATION/INSTALLATION INSTRUCTIONS

62' LAYBACK ARCH BACKSTOP

MODEL NO.

## LA-AB-62L