

STEELCRAFT PRODUCTS

P.O. Box 90365 - Pasadena, CA 91109
PHN 626-798-7401 FAX 626-798-1482

MODEL
ZE-65
EXTENSION FRAME

NOTE: NUMBER & LENGTH OF BRACES VARIES BY MODEL OF BACKBOARD

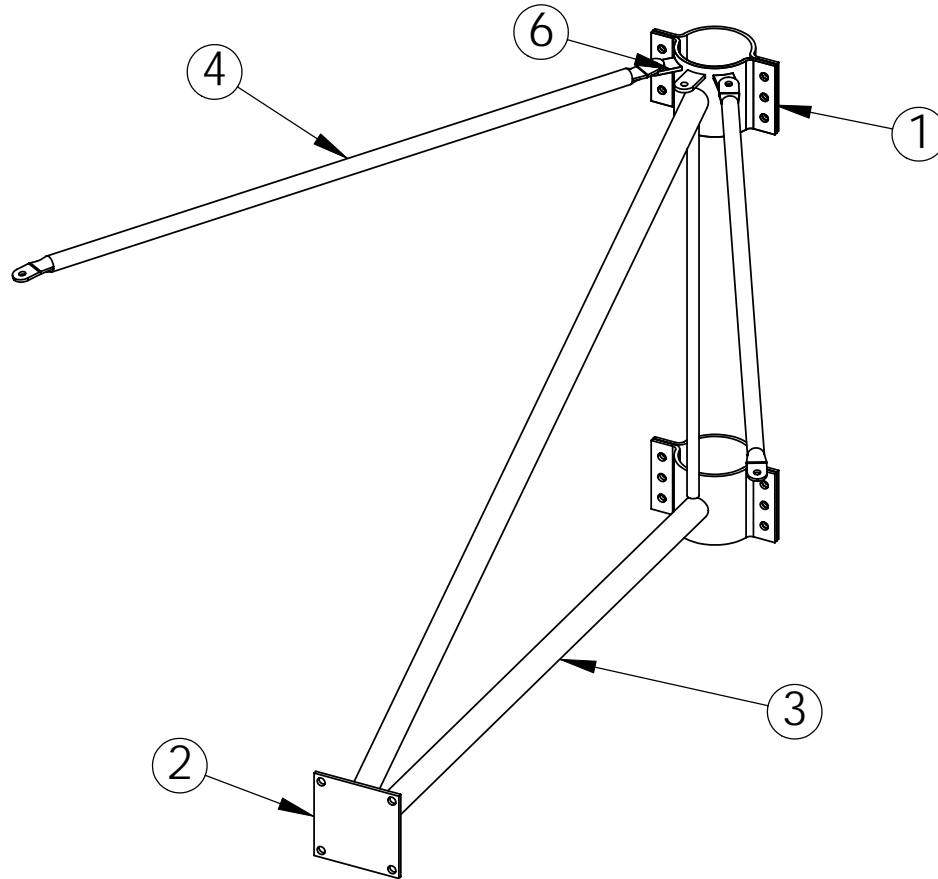

ZE-65 EXTENSION FRAME

ITEM	QTY.	PART NO.	DESCRIPTION
1	4	F02ZE000	STANDARD SIX HOLE CLAMP (5-9/16" OD)
2	1	F02ZEA01	2-3/8" OD GALV. FRAME w/ STL. PLATE & (2) HALF CLAMPS
3	2	F04ZE002	1" OD GALV. STEEL TUBE
4	12	P01ZE000	1/2" X 1 1/2" BOLTS w/ N, LW & W FOR ATTACH TO POST
5	4	P01ZE001	5/16" X 1-1/2" BOLTS w/ N, LW & W FOR BRACES

NOTE: SPECIFICATIONS ARE SUBJECT TO CHANGE

DO NOT SCALE DRAWING

DATE: 7/7/09

DRAWN BY: AFS