

STEELCRAFT PRODUCTS

P.O. Box 90365 - Pasadena, CA 91103
PHN 626-798-7401 FAX 626-798-1482

MODEL
12C46
CURVED BASKETBALL
POST

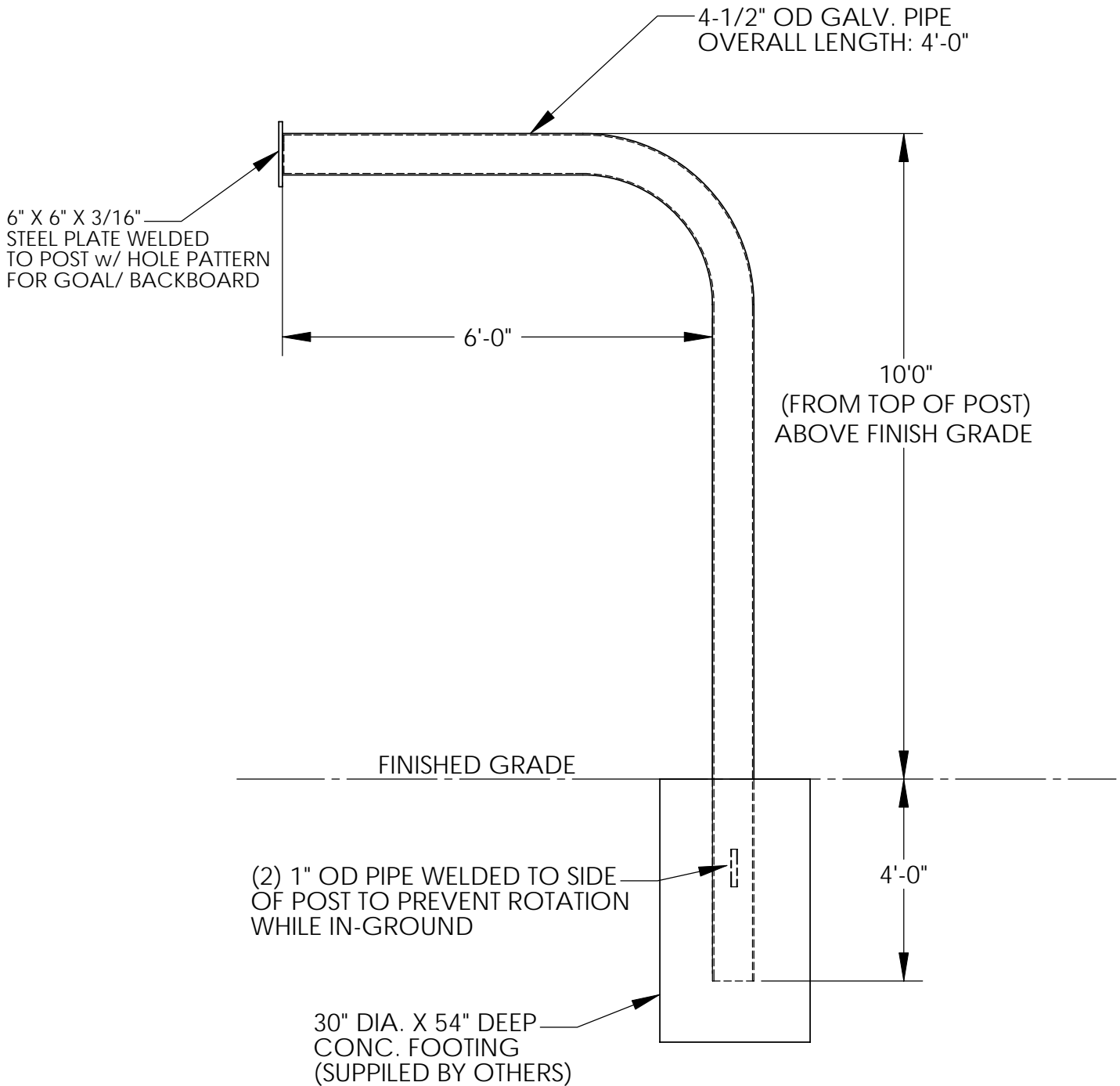

NOTE: SPECIFICATIONS ARE SUBJECT TO CHANGE

DO NOT SCALE DRAWING

DATE: 9/11/06

DRAWN BY: AFS

STEELCRAFT PRODUCTS

P.O. Box 90365 - Pasadena, CA 91103
 PHN 626-798-7401 FAX 626-798-1482

MODEL
 12C46
 w/ FAN SHAPE EXT.
 BASKETBALL POST

NOTE: NUMBER OF BRACES VARIES BY MODEL OF BACKBOARD

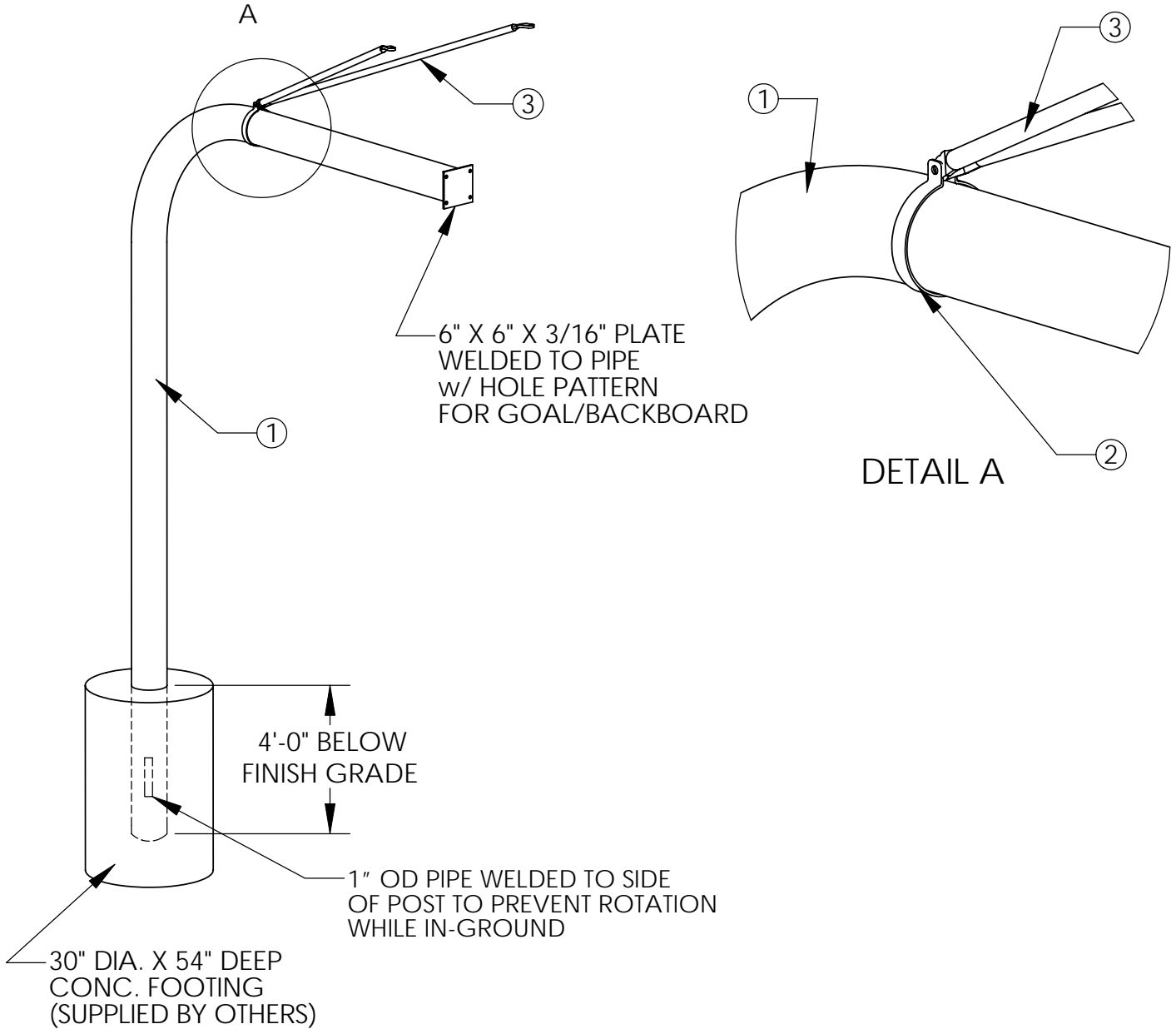

ITEM	QTY.	DESCRIPTION
1	1	4-1/2" OD, SCH. 40 GALV. PIPE @ 14'-0" w/ 6'-0" EXT.
2	1	BRACE BAND w/ 3/8" X 1-3/4" HEX BOLT w/ 2N, FW
3	2	6' X 1" OD GALV. TUBE BRACING (FAN SHAPED BACKBOARD)
4	3	5/16" X 1-1/4" HEX BOLT w/ N, W & LW FOR BRACES

NOTE: SPECIFICATIONS ARE SUBJECT TO CHANGE

DO NOT SCALE DRAWING

DATE: 9/17/08

DRAWN BY: AFS

STEELCRAFT PRODUCTS

P.O. Box 90365 - Pasadena, CA 91103
 PHN 626-798-7401 FAX 626-798-1482

MODEL
 12C46
 w/ RECT. SHAPE EXT.
 BASKETBALL POST

NOTE: NUMBER OF BRACES VARIES BY MODEL OF BACKBOARD

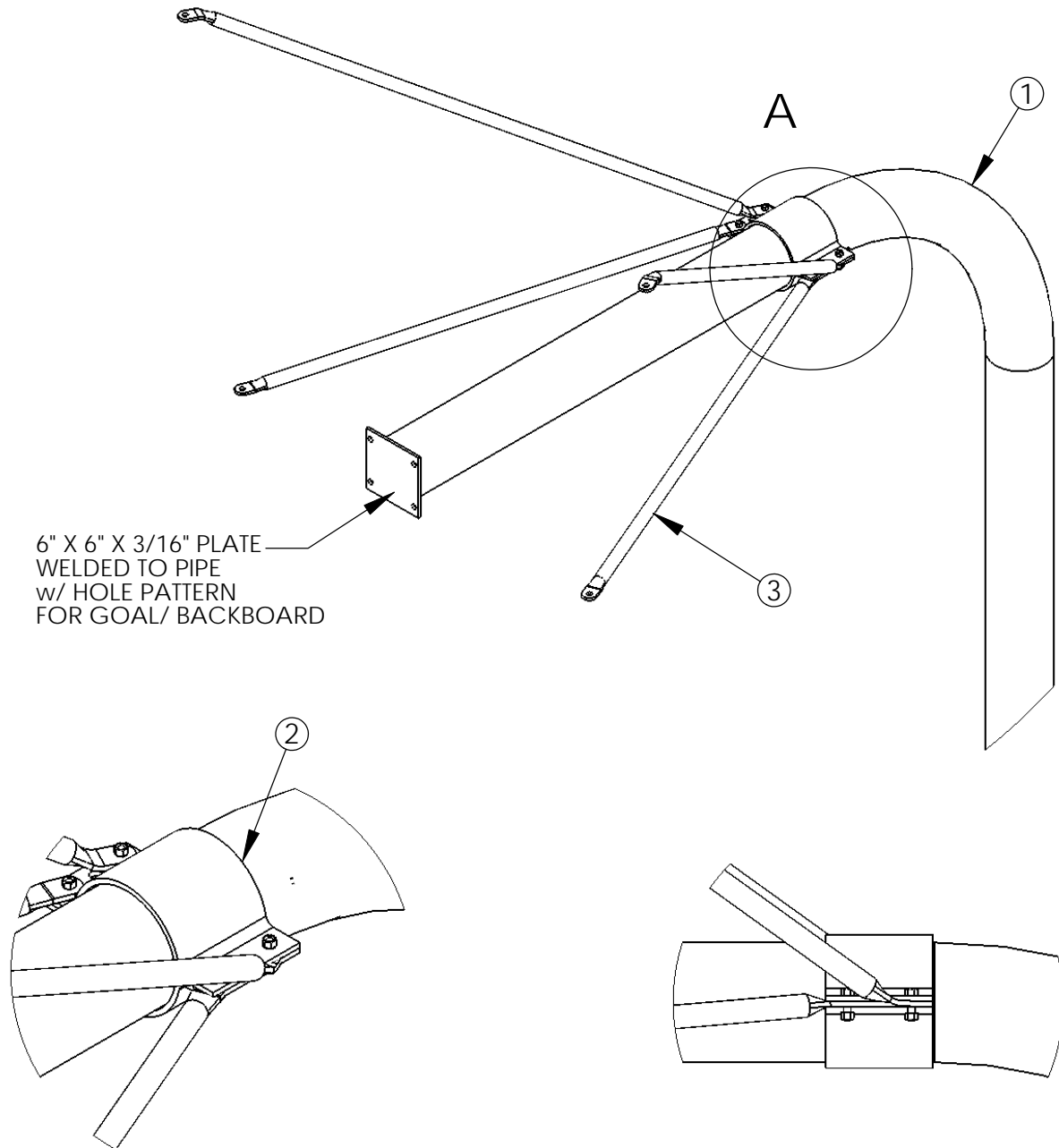

DETAIL A

ITEM	QTY.	DESCRIPTION
1	1	4-1/2OD, SCH. 40 GALV. PIPE @ 14'-0" w/ 6'-0" EXT.
2	2	HALF CLAMP FOR BRACE CONNECTION (TOP & BOTTOM)
3	4	1" OD GALV. BRACE- TOP & BOTTOM
4	4	1/2" X 2-1/4" HEX BOLT w/ LW, FW & LN
5	8	5/16" X 1-1/4" HEX BOLTS w/ LW, FW & LN

NOTE: SPECIFICATIONS ARE SUBJECT TO CHANGE

DO NOT SCALE DRAWING

DATE: 9/17/08

DRAWN BY: AFS