

STEELCRAFT PRODUCTS

P.O. Box 90365 - Pasadena, CA 91103
 PHN 626-798-7401 FAX 626-798-1482

MODEL
 12C046
 CURVED BACK TO BACK
 BASKETBALL POST

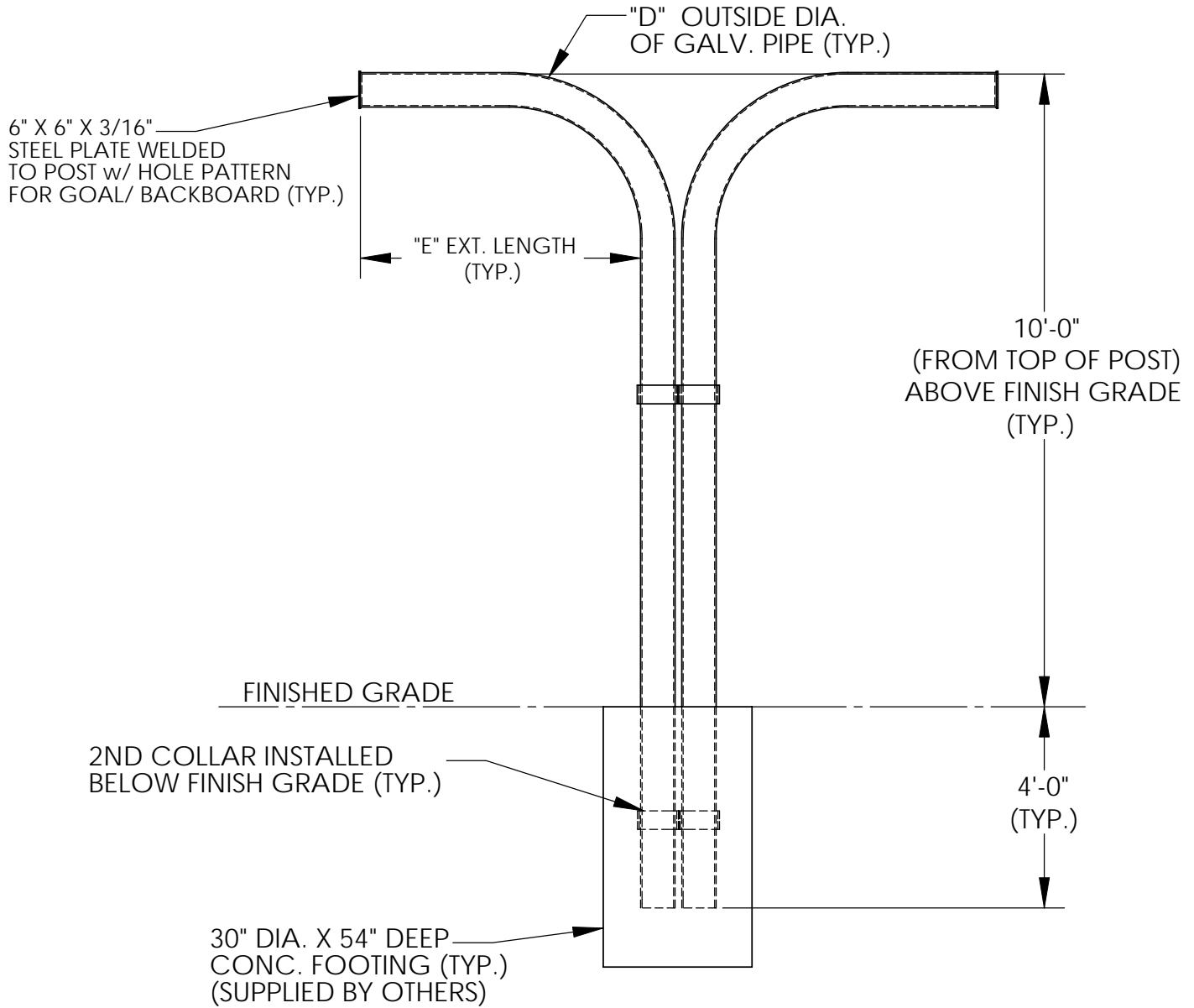

MODEL	"D" OUTSIDE DIA. OF POST	"E" EXT. LENGTH	OVERALL POST LENGTH
12C034	3-1/2"	4'	14'-0"
12C044	4-1/2"	4'	14'-0"
12C046	4-1/2"	6'	14'-0"

NOTE: SPECIFICATIONS ARE SUBJECT TO CHANGE

DO NOT SCALE DRAWING

DATE: 8/22/08

DRAWN BY: AFS

STEELCRAFT PRODUCTS

P.O. Box 90365 - Pasadena, CA 91109
 PHN 626-798-7401 FAX 626-798-1482

MODEL
 12C046
 w/ FAN SHAPE EXT.
 BASKETBALL POST

NOTE: NUMBER OF BRACES VARIES BY MODEL OF BACKBOARD

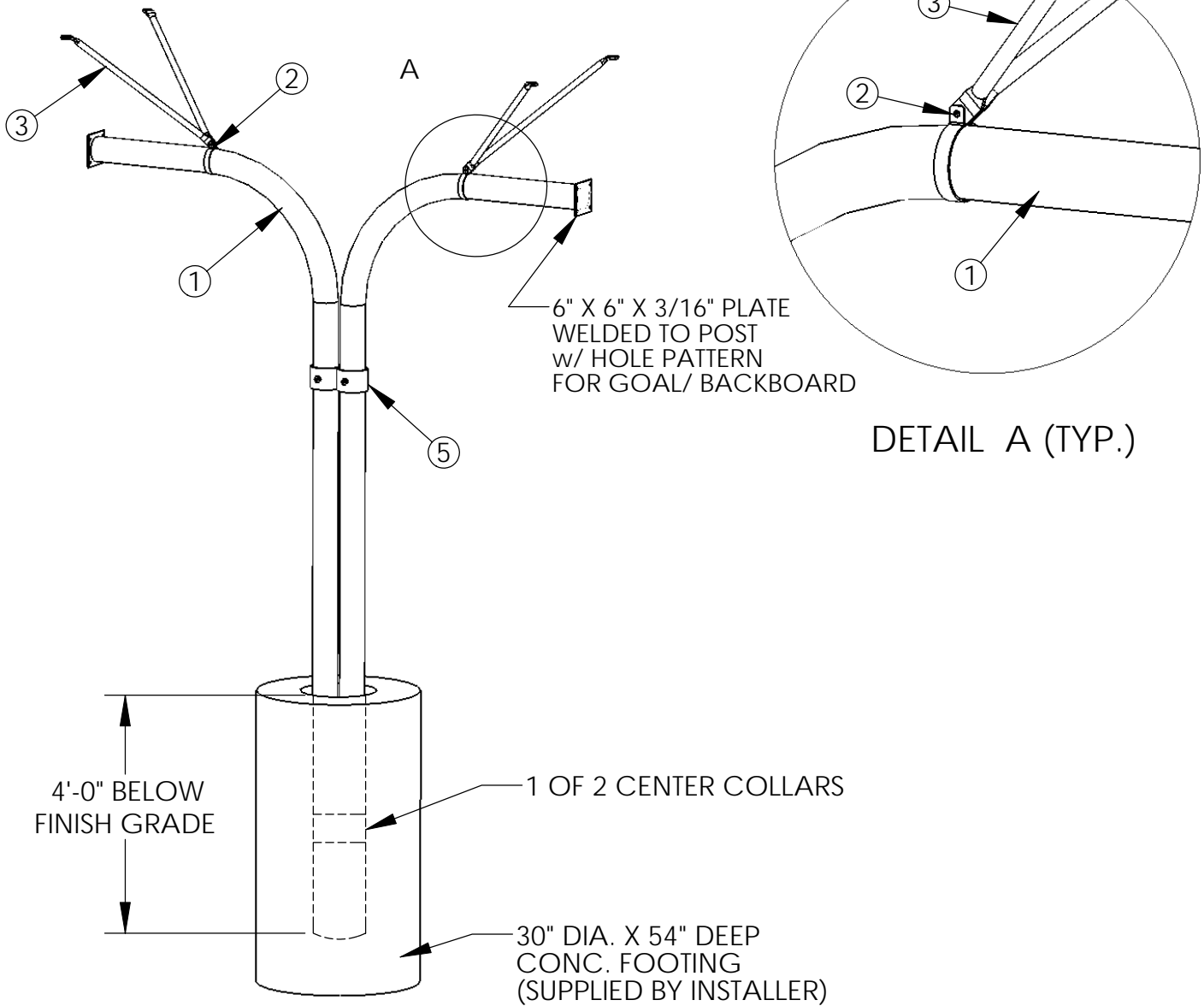

ITEM	QTY.	DESCRIPTION
1	2	4-1/2" OD GALV. PIPE @ 14'-0" w/ 6'-0" EXT.
2	2	BRACE BAND w/ 3/8" X 1-3/4" HEX BOLT w/ 2N, FW
3	4	4' X 1" OD GALV. TUBE BRACING
4	3	5/16" X 1-1/4" HEX BOLT w/ N, W & LW FOR BRACES
5	2	CENTERING COLLAR- ONE BURIED IN FOOTING

NOTE: SPECIFICATIONS ARE SUBJECT TO CHANGE

DO NOT SCALE DRAWING

DATE: 9/21/08

DRAWN BY: AFS

STEELCRAFT PRODUCTS

P.O. Box 90365 - Pasadena, CA 91109
 PHN 626-798-7401 FAX 626-798-1482

MODEL
 12C046
 w/ RECT. SHAPE EXT
 BASKETBALL POST

NOTE: NUMBER OF BRACES VARIES BY MODEL OF BACKBOARD

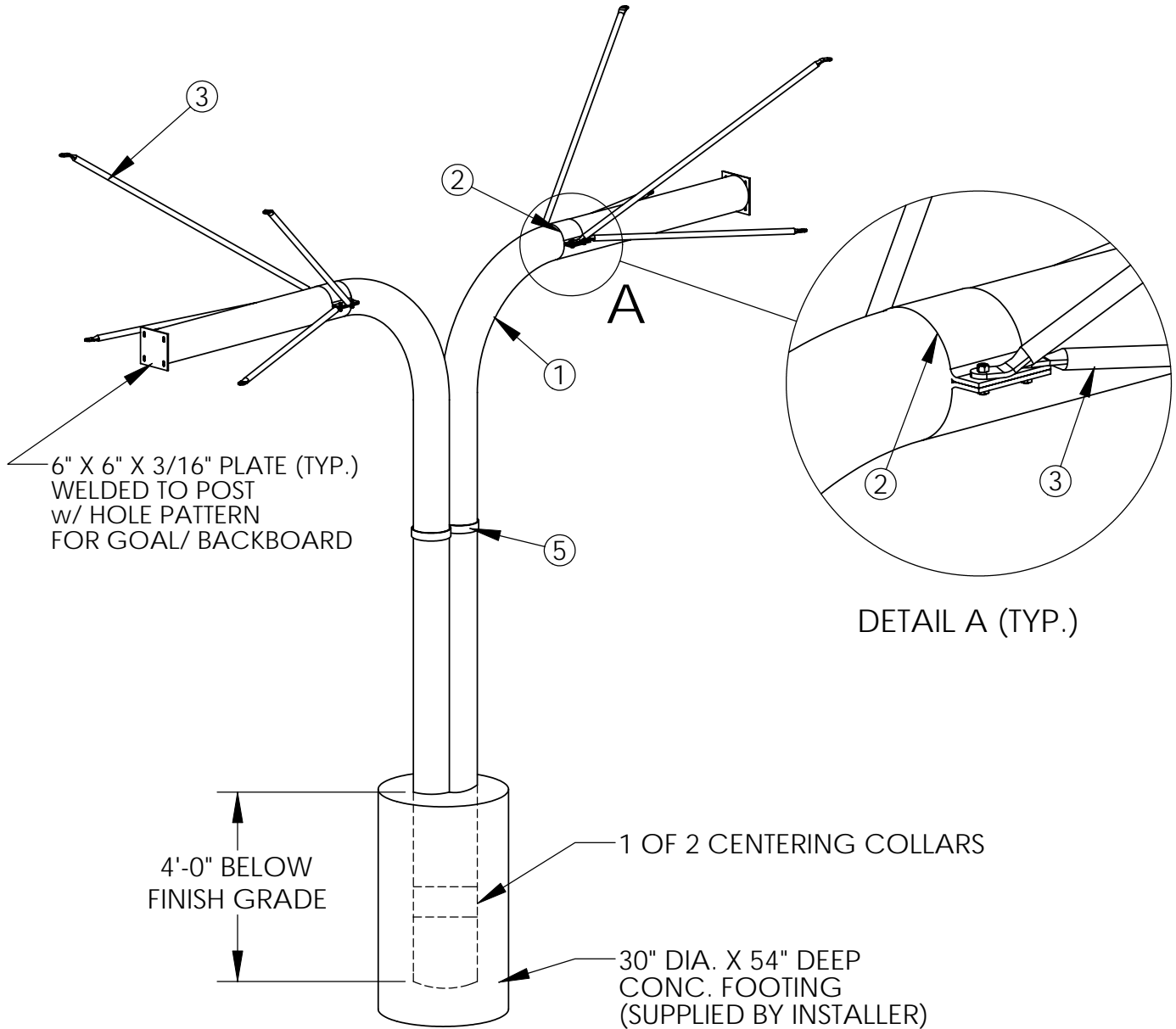

ITEM	QTY.	DESCRIPTION
1	2	4-1/2" OD GALV. PIPE @ 14'-0" w/ 6'-0" EXT.
2	4	HALF CLAMP FOR BRACE CONNECTION (TOP & BOTTOM)
3	8	1" OD GALV. TUBE BRACING
4	8	1/2" X 2-1/4" HEX BOLT w/ LW, FW & LN
5	8	5/16" X 1-1/4" HEX BOLT w/ LW, FW & LN
6	2	CENTERING COLLAR- ONE BURIED IN FOOTING

NOTE: SPECIFICATIONS ARE SUBJECT TO CHANGE

DO NOT SCALE DRAWING

DATE: 9/21/08

DRAWN BY: AFS