

STEELCRAFT PRODUCTS

P.O. Box 90365 - Pasadena, CA 91109
 PHN 626-798-7401 FAX 626-798-1482

MODEL
 1244PC
 w/ FAN SHAPE EXT.
 BASKETBALL POST

NOTE: NUMBER OF BRACES VARIES BY MODEL OF BACKBOARD

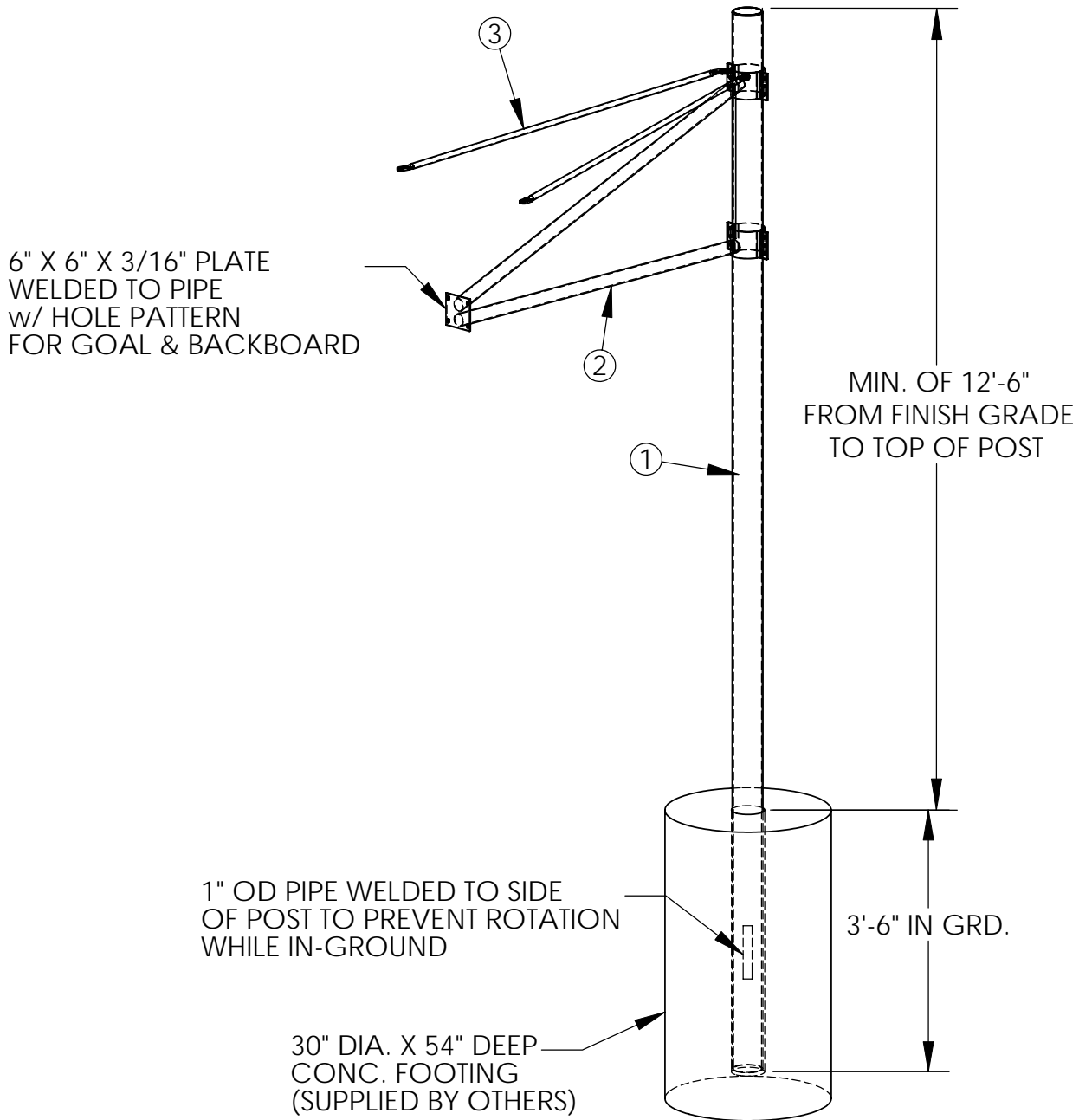

ITEM	QTY.	DESCRIPTION
1	1	5-9/16"OD POWDER COATED PIPE w/ WELDED CAP & 4'-0" EXT.
2	1	4'-0" EXT. FRAME
3	1	1" OD P/C TUBE BRACING

NOTE: SPECIFICATIONS ARE SUBJECT TO CHANGE

DO NOT SCALE DRAWING

DATE: 6/30/09

DRAWN BY: AFS

STEELCRAFT PRODUCTS

P.O. Box 90365 - Pasadena, CA 91109
 PHN 626-798-7401 FAX 626-798-1482

MODEL
 1244PC
 w/ RECT. SHAPE EXT.
 BASKETBALL POST

NOTE: NUMBER OF BRACES VARIES BY MODEL OF BACKBOARD

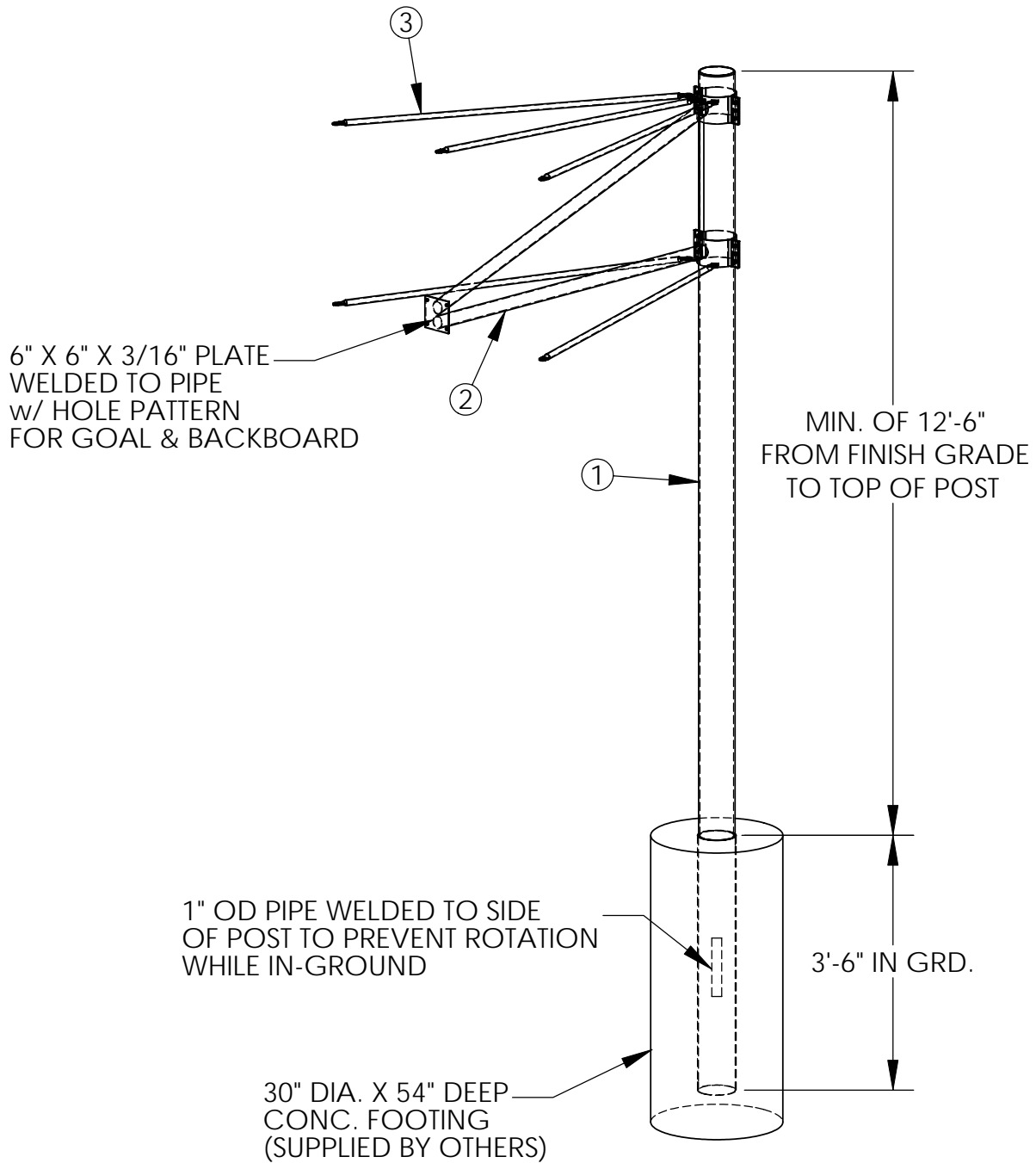

ITEM	QTY.	DESCRIPTION
1	1	5-9/16"OD POWDER COATED PIPE w/ WELDED CAP & 4'-0" EXT.
2	1	4'-0" EXT. FRAME
3	1	1" OD P/C TUBE BRACING

NOTE: SPECIFICATIONS ARE SUBJECT TO CHANGE

DO NOT SCALE DRAWING

DATE: 6/30/09

DRAWN BY: AFS